

LÖFFLER
bewegen

knopfler



knopfler 72, KN 9759



knopfler 98, KN 9959



knopfler 85, KN 9859 - upholstery in C 280 Cottbus

knopfler - calm elegance

knopfler is a chair for strong personalities who believe that sitting comfortably goes hand in hand with industriousness. With its full length backrest and the precisely placed buttons it epitomises fine craftsmanship. An immensely pleasurable and very relaxing sitting experience.



knopfler 85, KN 9859
seat in E 346 leather,
back in C 520 Moers

Table **holzer** HZ 1014
beech Natural, top Grey

holzer coat rack HZ 1010
beech Natural



knopfler 85, KN 9859
upholstery in C 523 Marl

Table **holzer** HZ 1004
walnut



knopfler 98, KN 9959
upholstery in E 347 leather

Table holzer HZ 1004
walnut





knopfler - the most comfortable Seating that Moves

knopfler is meticulous design. Sitting in **knopfler** is like putting on a cosy down jacket. **knopfler** meets all the aesthetic and functional demands an office chair should fulfill. It is a home away from home - wherever you happen to be.

knopfler 98, KN 9959
upholstery in E 346 leather

Table **holzer HZ 1004**
walnut

Armchair **holzer HZ 1001**
walnut
upholstery in E 346 leather

Stool **fungo FU 9000**
upholstery in Black

knopfler - comfortable seating for successful teams

knopfler is equally at home in both executive management suites and open-plan team offices. **knopfler** - smooth and efficient ERGO TOP technology combined with super-comfortable sitting - the result: doing your job becomes a healthy, concentrated and enjoyable experience.

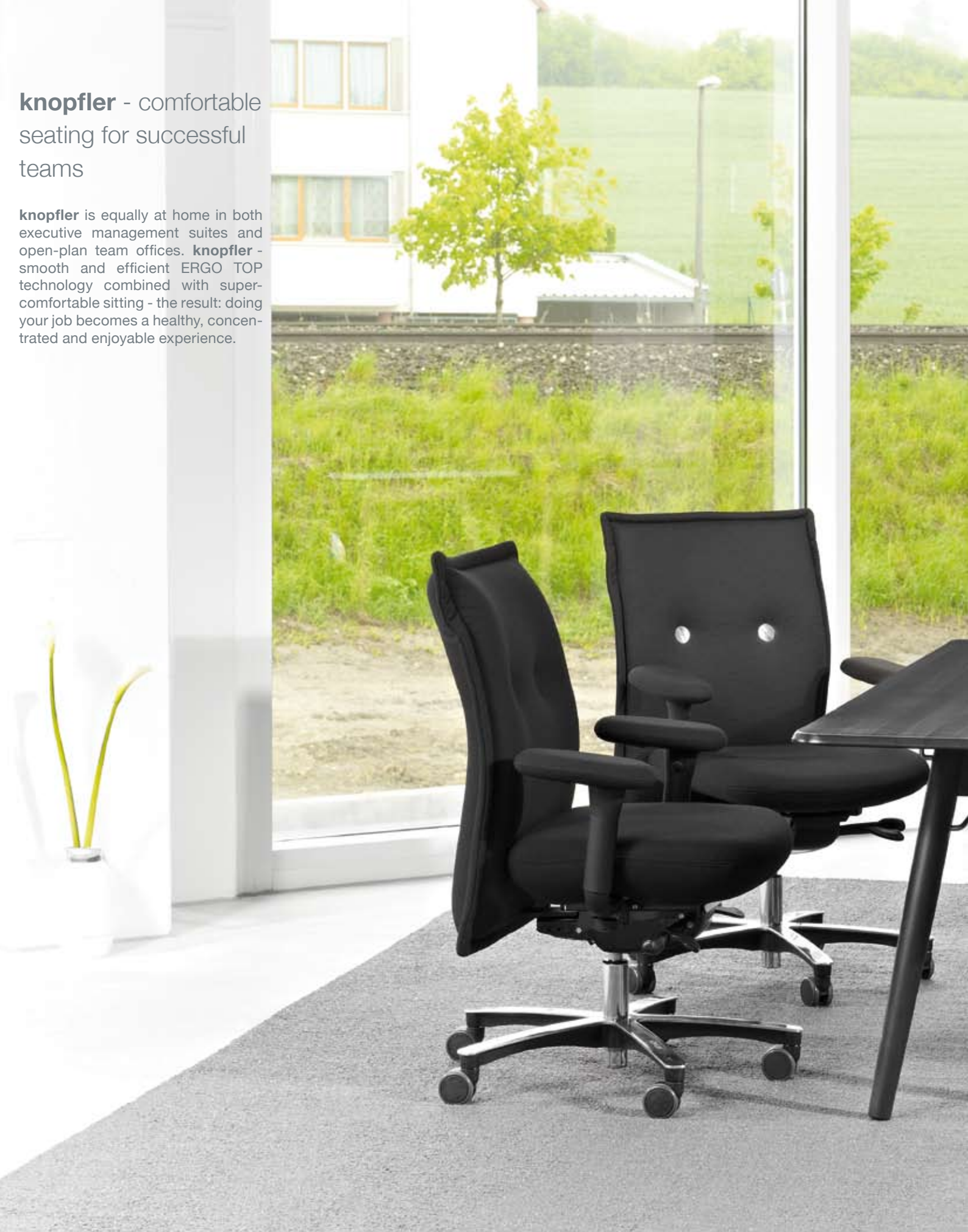



knopfler 72, KN 9759
upholstery in C 280 Cottbus,
buttons mother-of-pearl

Table **holzer** HZ 1004
beech Black

knopfler - creative inspiration

knopfler offers scope for individuality thanks to a wide range of colour and material combinations. A creative office chair eminently suited for projecting corporate identity. We are happy to customise **knopfler** taking your company's particular image requirements into account.



knopfler 98, KN 9959
seat in E 346 leather
back in C 521 Salzgitter

Table **holzer** HZ 1014
beech Natural, top White

knopfler - product information

LÖFFLER has designed office chairs that take our inborn urge to move into account and are therefore good for our health for decades - simply, naturally and excellently designed. ERGO TOP is a seating concept which offers the body the scope to move the way it needs to. Our bodies know what is best for them - and LÖFFLER seating gives them the freedom to do it. Stimulation without strain is the guiding principle for healthy sitting. Sitting as a pleasantly stimulating experience to promote physical and mental fitness.

knopfler, spacious and inviting, promises comfort and invites immediate trust and appreciation. The **knopfler** range's three different back heights meet all needs in terms of both functionality and design: 72 cm, 85 cm or 98 cm. Seat and back covered in either fabric or leather. Padded arm supports in either leather or fabric and always adjustable in all three directions. Frame: X base made from die cast aluminium, finish either black or polished.



Löffler has developed a unique addition to the synchronous mechanism: the patented ERGO TOP technology, a fully flexible seat, enabling the sitter to tilt the seat forward to encourage the recommended upright posture. ERGO TOP also allows the seat to move sideways, prompting the pelvis to tip and tilt very much as it would naturally when walking, thus providing exercise for the spine's neuromuscular stabilisation mechanisms.

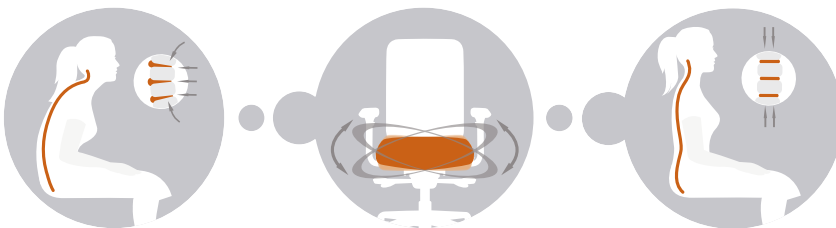

Usual seated posture:
Sitting on a good quality, but conventional office swivel chair (no backrest contact) leads to rounded back development, there is hardly any muscle activity. The spinal discs harden - leading invariably to back complaints.

ERGO TOP - fully flexible seat:
the spinal discs retain their elasticity, the gentle movement ensures a constant supply of nutrients.

Ergonomic seated posture with ERGO TOP:
the pelvis is automatically tipped forward, yet the body stays in an overall upright position - even without touching the backrest.

The ERGO TOP result:
a strong, well-trained back.

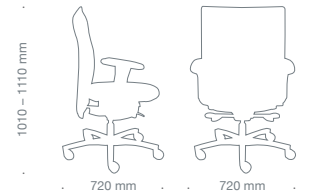

knopfler 72, KN 9759, seat height 420 - 520 mm

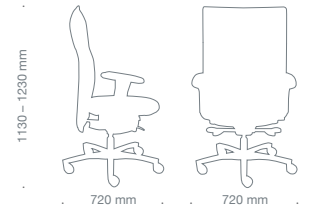

knopfler 85, KN 9859, seat height 420 - 520 mm

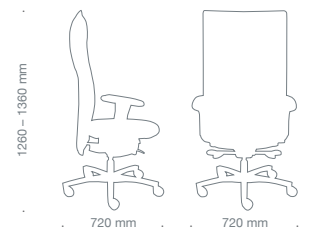

knopfler 98, KN 9959, seat height 420 - 520 mm

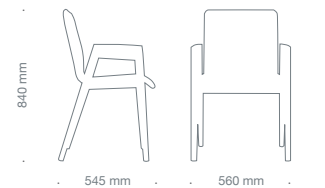

Armchair holzer HZ 1001, padding 5 mm, seat height 460 mm

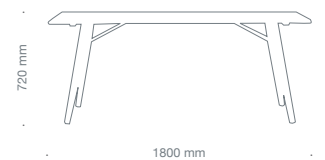
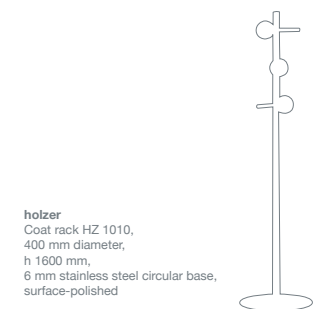

Table holzer HZ 1004, width: 800 mm



Stool fungo FU 9000, seat height 460 mm



holzer Coat rack HZ 1010, 400 mm diameter, h 1600 mm, 6 mm stainless steel circular base, surface-polished



Werner Löffler, ergonomic seating optimiser, passionate chair and seating furniture collector.

Fritz Močnik, designer and developer responsible for achieving the ergonomic seating - top-class materials - sophisticated design balancing act.